

* closed hole

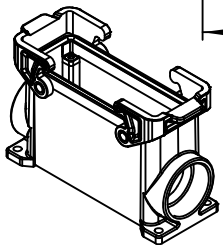
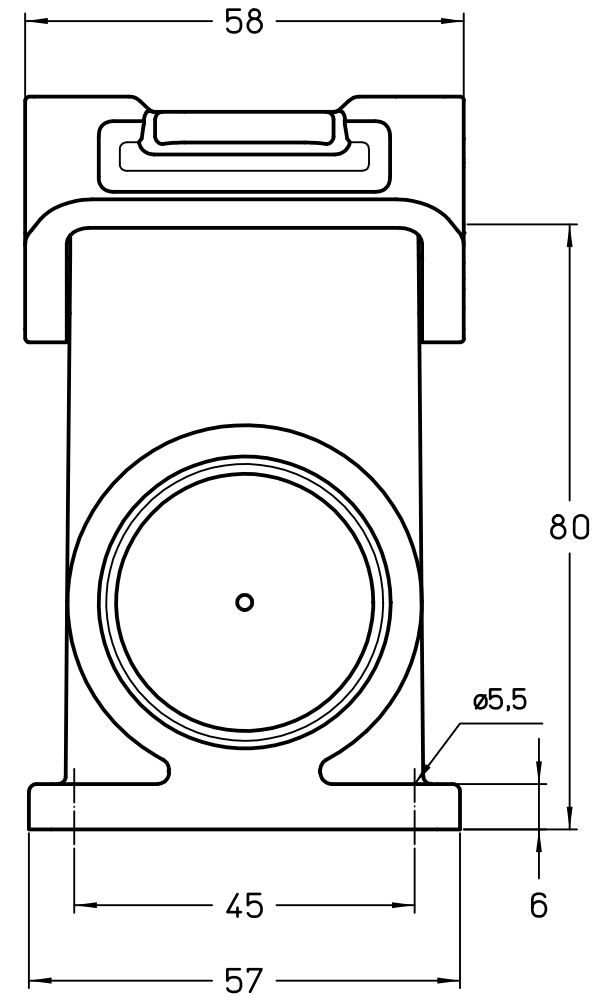
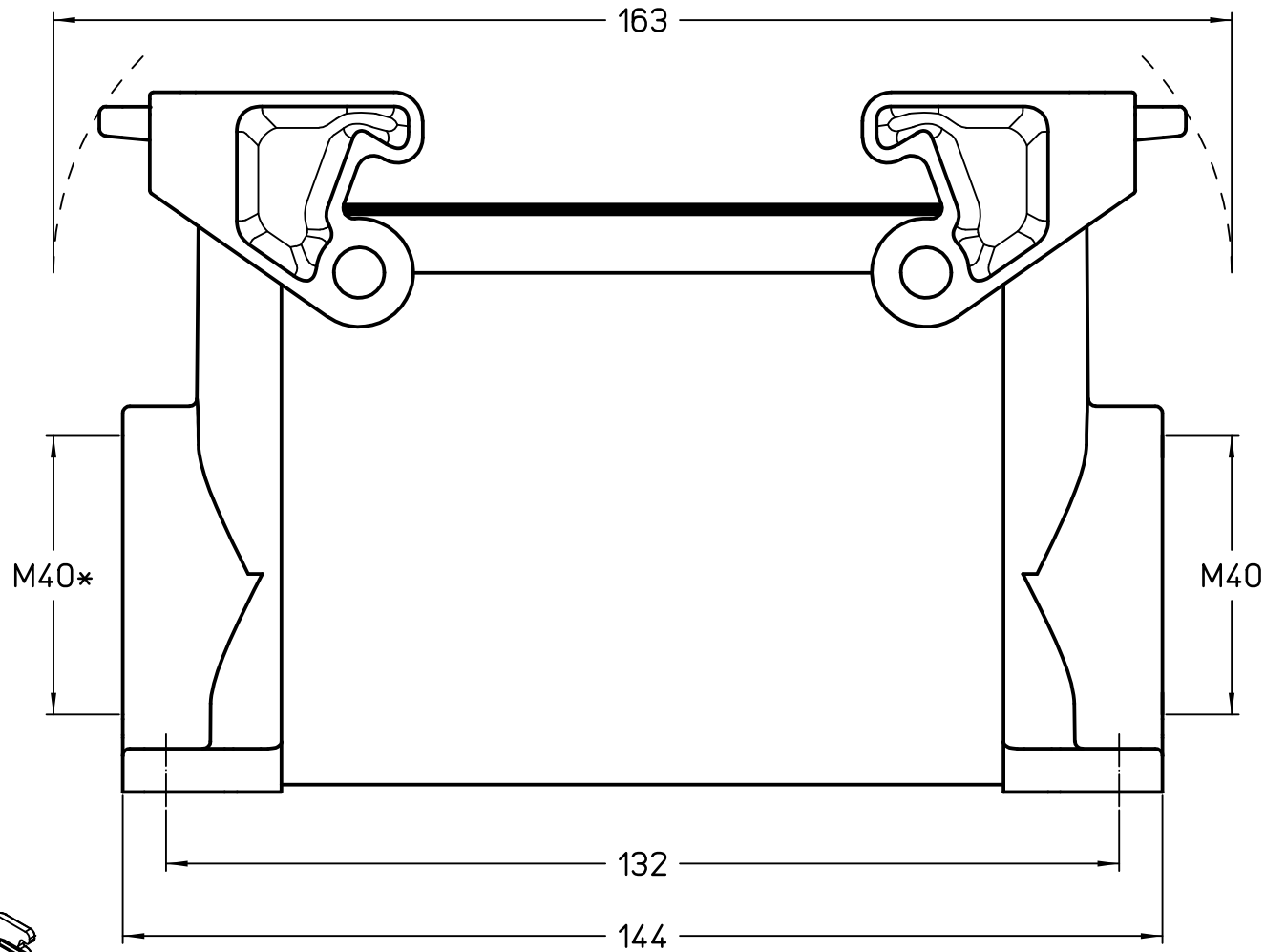

Dimensions
in mm

Simplified representation with dimensions without tolerance

Original Size A4

TAPH 24.40B

Date 15/02/22

Insulating surface mounting housing, size "104.27", 1x M40 side entry,

Sign. G. Renna

with 2 levers, with integrated PE jumpers - HYGIENIC

Scale
1:1

